

Controller PCSol 150



FOR SOLAR COLLECTORS



QUALITY INTERNATIONAL
FORUM JAKOŚCI 2008

ISO 9001 ISO 14001 OHSAS 18001

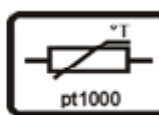
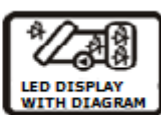
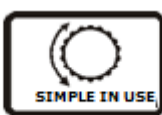
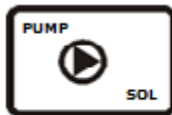

INSTALLATION AND OPERATION MANUAL

REVISION: 1.1
SOFTWARE: 1.xx

26-05-2015

Contents

1. SAFE INSTALLATION AND USE	4
2. GENERAL	4
3. DIRECTIVE WEEE 2002/96/EC.....	5
4. DOCUMENT KEEPING.....	5

OPERATING MANUAL 7

5. OPERATION	8
5.1. Temperature display	8
5.2. Screen navigation.....	8
5.3. Temperature presets.....	9
5.3.1. TsDHW	9
5.3.2. TCOLmin	9
5.3.3. TCOLcr	9
6. CONTROLLER SETTINGS CHANGE -OPTIONS .9	
6.1. Setting of deltas $\Delta 4 \div \Delta 14$	10
6.2. Critical temperature alarm AL.....	10
6.3. Maximal DHW temperature - Max85 \div 9510	
7. CONTROLLER OPERATING ALGORITHM	10
8. ALARMS.....	11
9. SWITCHING OFF	12
9.1. Test of unit	12

INSTALLATION MANUAL 13

10. TECHNICAL DATA	14
10.1. Elements of the set.....	14
11. INSTALLATION	14
11.1. Installation of the controller	14
11.2. External circuits connection	15
12. DIAGRAM OF CONNECTIONS.....	16
12.1. Basic diagram of connections.....	16
12.1.1. Use of connectors.....	17
12.1.2. Power supply connection	17
12.1.3. Temperature sensor connection.....	17
13. HOW TO CLOSE CASING	18
14. FUSE REPLACEMENT	19
15. TROUBLESHOOTING	20

List of Figures

Fig. 2.1 Functional diagram	4
Fig. 5.1 Controller screen	8
Fig. 5.2 Collector temperature display.	8
Fig. 5.3 Reservoir temperature display.....	8
Fig. 5.4 Screen navigation.	8
Fig. 6.1 Controller option setting/checking	10
Fig. 9.1 Identifying software version	12
Fig. 11.1 How to open casing panel	14
Fig. 11.2 Incorrect method of casing opening	15
Fig. 11.3 Inside view with terminals	15
Fig. 12.1 Diagram of connections	16
Fig. 12.2 Using clamped terminals.....	17
Fig. 12.3 Power supply connection.....	17
Fig. 12.4 Connection of temperature sensors.....	18
Fig. 13.1 Casing closing first step	18
Fig. 13.2 Casing closing second step.....	18
Fig. 14.1 Fuse replacement	19
Fig. 15.1 Casing drawing for installation aid	21

1. SAFE INSTALLATION AND USE

The controller is designed only for household and similar use.

Before installation, service or maintenance and prior to making any connections, always disconnect power supply and make sure that the terminals and electric wires are not energized.

 When the controller is switched off using keyboard, the controller terminals are still under dangerous voltage.

 Controller may be used only for its intended purpose.

 It is required to use auxiliary protection automatics to protect hot water system (in case of controller or software malfunction).

 Programmable settings must be selected suitably to your system type, taking into account all of its operating conditions. Wrongful settings may cause the collector or reservoir malfunction (e.g. collector overheating, etc.).

 Programmed settings may be modified only by a person who read and understood this manual.

 Use only in heating systems that are set up in accordance with valid regulations.

 Electric system to which the controller is connected must be protected with a cut-out device suitable for expected loads.

 Never use the controller when its casing is damaged.

 In any case do not alter the controller components.

 The controller has micro-disconnection for connected devices (operation 2.B according to PN-EN 60730-1). It means that at 230V voltage supply the pump outlets have dangerous voltage, even if the pumps are not controlled.

 Do not allow children access to the controller.

 Before you open casing, first disconnect power supply from the unit.

 The controller must be installed in accordance to the requirements of EN 60335-1 standard, by qualified and authorized technician.

 Do not install the unit when connected to voltage.

 Do not operate the unit when it is malfunctioning or was repaired by unauthorized persons.

2. GENERAL

PCSoI 150 is an advanced electronic temperature controller designed for heat distribution from solar collectors to hot utility water reservoir. The controller is used to control solar circuit systems accordingly to indications from temperature sensors to recover highest possible energy from the collector.

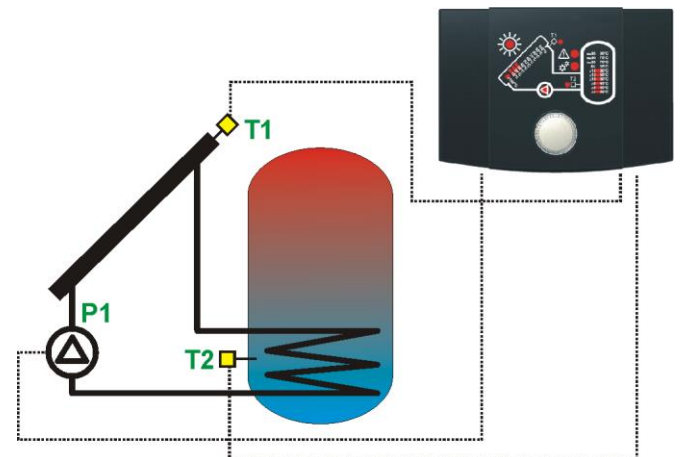

Fig. 2.1 Functional diagram

3. DIRECTIVE WEEE 2002/96/EC

The product you have purchased was designed and made using the highest quality components that may be recycled and reused.



If the product is marked with the above crossed bin symbol, it means that it meets requirements of the European Directive 2002/96/EC.

It is recommended to know your local electric and electronic products disposal system.

It is recommended to process in accordance with local regulations and not to dispose used products to household garbage containers. Proper disposal of outdated products will help to avoid potential adverse effects on the environment and human health.

4. DOCUMENT KEEPING

Please, keep carefully this installation and operating manual and any other relevant documents, so that they may be used at any time. In case when you move or sell the unit, please give the attached documents to its new user.

OPERATING MANUAL

PCSol 150

5. OPERATION

The controller has TOUCH&PLAY system that facilitates its operation by the knob with a button.

To switch the controller on press and keep the knob depressed for three seconds.



When on the controller automatically starts controlling the collector pump. Pump operation is described in section 7 about working algorithm.

When the controller is starting it runs a test. Detailed test description is in section 9.1.

The collector pump operation is indicated by illumination of the indicator icon under the pump icon. When the indicator is lit – the collector pump is working, when the indicator is not lit, it means that the pump is not working.

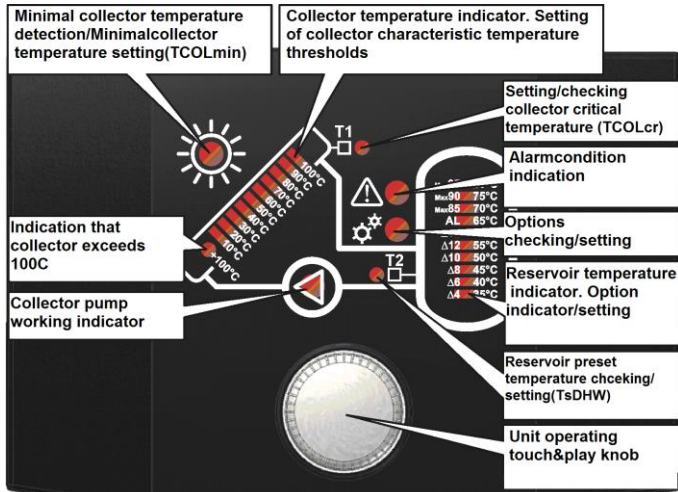

Fig. 5.1 Controller screen

5.1. Temperature display

Measured temperatures from both connected sensors are presented on PCSol 150 linear display indicators.

Number of lit segments increases along with the temperature rise. Measured temperature is shown with the step of 10°C for T1 sensor (collector's temperature) and 5°C for T2 sensor (DHW reservoir temperature). Subsequent segments of the indicator indicate respective temperatures reached in the sensor. Examples of the temperature display is presented in Fig. 5.3, Fig. 5.4

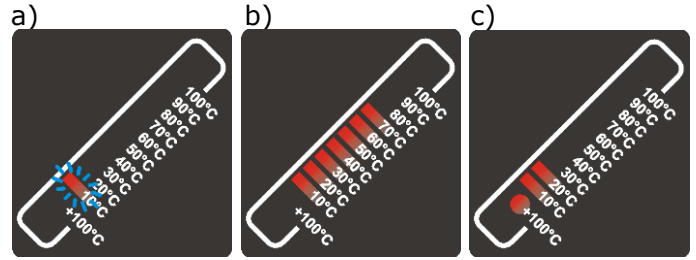

Fig. 5.2 Collector temperature display.

- a) collector temperature below 10°C
- b) collector temperature 70°C
- c) collector temperature 120°C

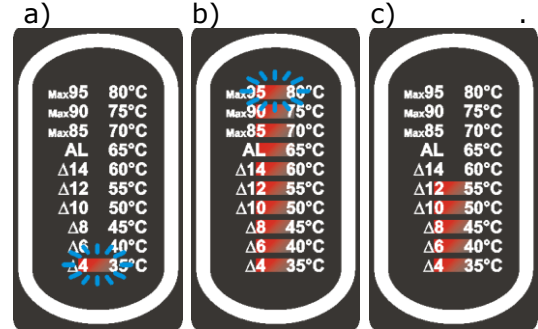

Fig. 5.3 Reservoir temperature display.

- a) reservoir temperature below 35°C
- b) reservoir temperature above 85°C
- c) reservoir temperature 55°C

5.2. Screen navigation

Screen position selection for edit is done by knob turning. Cursor position in selection mode is indicated by slow blinking of the indicator.

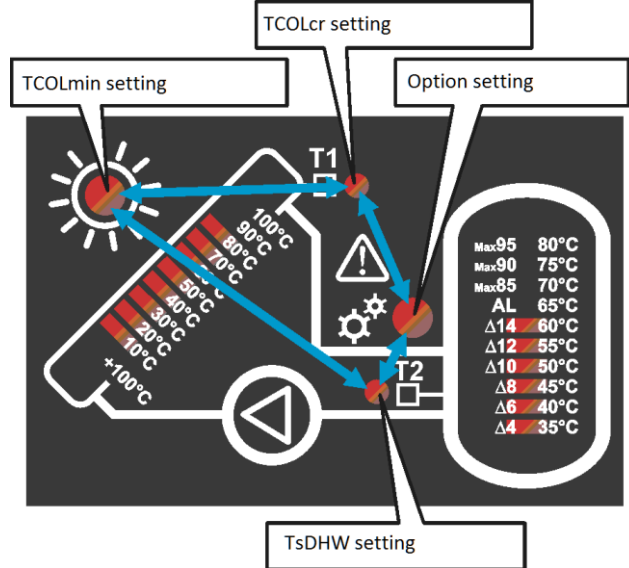

Fig. 5.4 Screen navigation.

Press the knob to start editing selected value. The indicator will blink fast.

To remove blinking cursor from the screen (in selection mode), keep the knob depressed for at least 3 seconds or leave the controller untouched for 10 seconds.

5.3. Temperature presets

The controller allows you to set the following temperatures:

- Temperature setting for reservoir **TsDHW**
- Minimal collector temperature **TCOLmin**
- Critical collector temperature **TCOLcr**

5.3.1. TsDHW

Temperature setting for DHW reservoir is a temperature to which the controller will load heat by controlling the collector pump on the base of temperature difference in T1-T2 sensors.

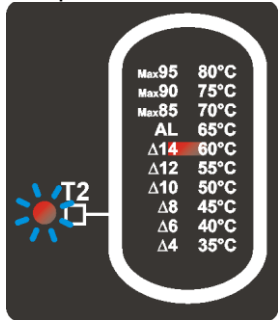

Temperature setting for DHW reservoir (**TsDHW**) may be checked by placing the cursor on T2 indicator.

pressing the knob (DHW fast open the knob preset

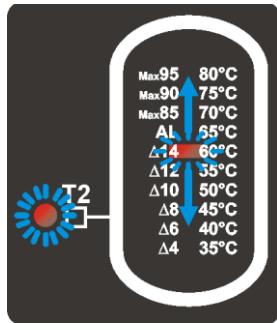

By (DHW fast open the knob preset

The temperature selection step is 5°C. Press again the knob to confirm the temperature change. If the cursor is left in edition mode for 10 seconds or the knob is depressed for 3 seconds, the controller will leave the preset change mode and any made change will be rejected.

5.3.2. TCOLmin

Minimal collector temperature is a temperature in T1 sensor that allows loading heat to DHW reservoir, if the temperature difference makes it possible. Below minimal collector temperature, the pump operation is stopped.

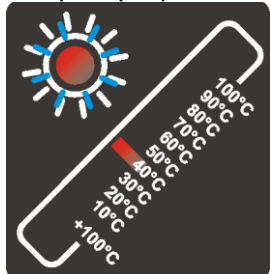

To read minimal collector temperature (**TCOLmin**) move the cursor to the indicator with sun symbol.

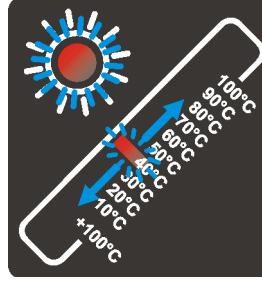

10°C. Confirmation and leaving edition is the same as for TsDHW preset.

5.3.3. TCOLcr

Critical collector temperature is such T1 sensor temperature that despite switching the collector pump off, after the temperature setting is reached, will allow discharge increasing heat in the collector.

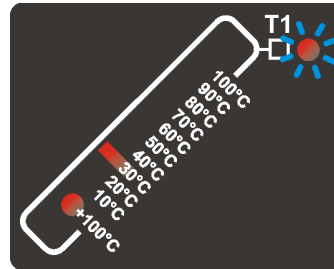

Critical collector temperature setting (**TCOLcr**) may be read by moving the cursor to T1 indicator.

Press the knob (T1 indicator will start fast blinking) to enter value editing mode. You may change the value by turning the knob. The temperature selection step is 10°C. Confirmation and leaving edition is the same as for TsDHW preset.

6. CONTROLLER SETTINGS CHANGE OPTIONS

Any option may be seen by moving the cursor to the option indicator (Fig. 5.4). To edit options press the knob on the options indicator. The options icon will start fast blinking. Now, turning the knob you may browse through the options. To modify any option, press the knob when the option is selected. If selected option is active, the indicator will be blinking fast. If the option is inactive, the indicator will be blinking slowly. The option values are shown on the left-hand side of the indicator.

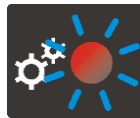
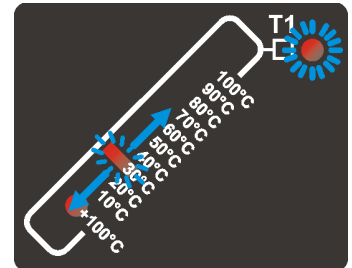

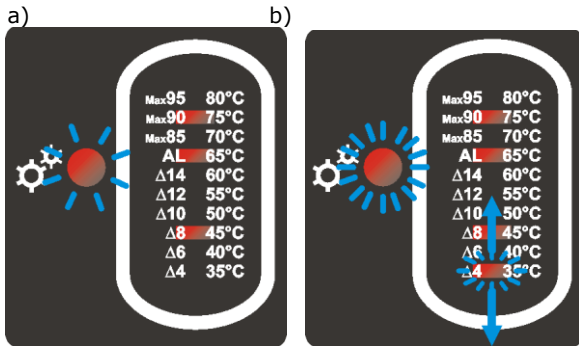

Fig. 6.1 Controller option setting/checking

a) option preset checking

b) option preset setting

Settings of each controller option are described below.

6.1. Setting of deltas $\Delta 4 \div \Delta 14$

$\Delta 14$	The controller allows to set temperature difference $dT=T1-T2$ that will start the collector pump. Possible setting values are: 4, 6, 8, 10, 12, 14K.
$\Delta 12$	
$\Delta 10$	
$\Delta 8$	
$\Delta 6$	
$\Delta 4$	

6.2. Critical temperature alarm

AL

AL Critical temperature is such collector temperature (T1 sensor) that despite collector pump stopping, after reaching reservoir temperature preset, will start collector pump in order to discharge excessive heat from the collector.

The controller allows you to turn on or off loud alarm for the collector critical temperature. If **AL** option is off, the controller will not sound audible alarm when the critical temperature is reached, but it will take alarm action (discharge heat from the collector into the reservoir).

6.3. Maximal DHW temperature - Max85÷95

Max95	The controller allows you to set maximal temperature for the reservoir. It is T2 temperature above which the controller will start the reservoir overheating alarm and it will stop heat loading to the reservoir.
Max90	
Max85	

This alarm has the highest priority and it will always stop the collector pump operation. It means that even in case of critical collector temperature, the reservoir overheating alarm will disable the collector pump from further operation.

It possible to set three values for the reservoir maximal temperature option: 85, 90, 95°C

7. CONTROLLER OPERATING ALGORITHM

When switched on the controller automatically starts to control the collector pump operation.

When the T1 sensor temperature reaches minimal collector operation value (TCOLmin), the controller will enable the collector pump operation. Such status is indicated by illumination of the sun symbol indicator. When the collector temperature drops two degrees below minimal temperature preset, the sun symbol will go off and the controller will disable the collector pump, if the last was working.

 The collector minimal temperature $TDHWmin$ is set by selecting edition at the sun symbol indicator

If the temperature difference between the collector and reservoir (T1-T2) exceeds value set in options as $d4 \div 14$ and the minimal collector temperature is reached (sun indicator is lit), the controller will start the collector pump and it will be loading heat into the reservoir (sun indicator is lit) until the temperature difference $T1-T2 < dT-2$ (current dT is lower than preset by two degrees) or the collector temperature (T1 sensor) drops below minimal collector temperature (TCOLmin-2). Then, the collector pump will be turned off.

The controller turns the collector pump off and on in cycles, depending on sunlight intensity and reservoir conditions, by the time when the DHW reservoir preset temperature (TsDHW) is reached.

 The reservoir preset temperature $TsDHW$ is set by selecting edition at the T2 indicator

When the DHW reservoir preset temperature is reached, the controller will stop the collector pump, until the reservoir temperature (T2 sensor) is lower than the preset by one degree ($T2 < TsDHW-1$). Then, the controller will restart the collector pump, if current conditions allow the reservoir loading.

When the collector pump is stopped, because the reservoir preset temperature has been reached, the controller will monitor the collector temperature (T1 sensor) and if it exceeds preset value $TCOLcr$, the controller will start the collector pump to discharge the collector's critical temperature. When the collector temperature drops in relation to $TCOLcr$ preset by 2°C, the controller will stop to force its operation.

 The collector critical temperature $TCOLcr$ is set by selecting edition at the T1 indicator

Cyclical discharge of heat from the collector may be only up to the time when DHW reservoir maximal temperature is reached. Then, the controller will not let loading heat into the reservoir, even if critical temperature has been reached in the collector.

 The reservoir maximal temperature TDHW_{max} is set in option menu, available values are max85, max90, max95

Reservoir overheating alarm will be stopped when the reservoir temperature drops in relation to preset by 2 degrees.

If the collector temperature (T1 sensor) exceeds 180°C, the collector pump operation will be stopped and the collector maximal temperature alarm will be signaled.

8. ALARMS



The controller alarms by acoustic signal and display alarm indicator blinking. The unit recognizes five alarm situations that may be identified in the controller screen as described in the table below.

List of alarms

T1 sensor malfunction, interruption

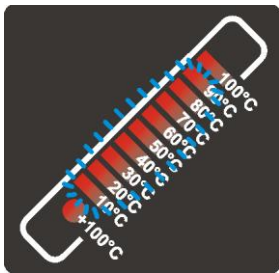

Alarm on incorrect operation or damage to **T1** sensor. Signals interruption in T1 sensor circuit. Check if the sensor is not e.g. off the unit or the connecting wire is cut.

Collector pump operation will be stopped.

During the alarm the collector temperature indicator for 10÷90°C temperatures is blinking, while 100°C temperature is lit steadily.

T1 sensor malfunction, short circuit

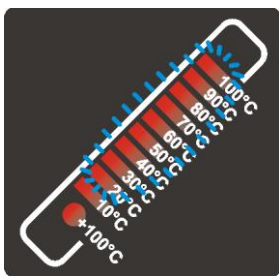

Alarm on incorrect operation or damage to **T1** sensor. Signals short circuit in T1 sensor circuit. Check connections and temperature sensor wiring for short circuit caused e.g. by mechanical damage of wire, crushed sensor tube

or melted insulation.

Collector pump operation will be stopped.

During the alarm the collector temperature indicator for 20÷100°C is blinking, while 10°C temperature is lit steadily.

T2 sensor malfunction, interruption

Alarm on incorrect operation or damage to **T2** sensor. Signals interruption in T2 sensor circuit. Check if the sensor is not e.g. off the unit or the connecting wire is cut.

Collector pump operation will be stopped.

During the alarm the collector temperature indicator for 35÷75°C is blinking, while 80°C temperature is lit steadily.

T2 sensor malfunction, short circuit

Alarm on incorrect operation or damage to **T1** sensor. Signals short circuit in T1 sensor circuit. Check connections and temperature sensor wiring for short circuit caused e.g. by mechanical damage of wire, crushed sensor tube or melted insulation.

Collector pump operation will be stopped.

During the alarm the collector temperature indicator for 40÷80°C is blinking, while 35°C temperature is lit steadily.

DHW reservoir overheating

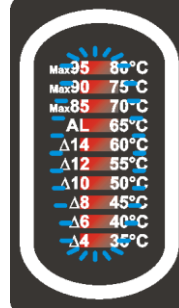

Alarm on hot water reservoir overheating. It is initiated when the reservoir temperature reaches value set in options as **max**. It means excessive heat in reservoir. Frequent alarms may indicate too low heat capacity of the reservoir for given collector surface.

Collector pump operation will be stopped.

Alarm will be off and the pump operation restarted, when the reservoir temperature drops by two degrees in relation to max preset.

During alarm the reservoir temperature indicator (entire) is blinking.

Collector critical temperature

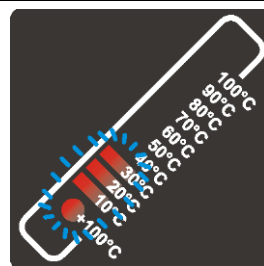

Alarm on reaching collector critical temperature preset. If the alarm is not connected with switching off the collector pump when set TS sensor temperature is reached, it may indicate too low pump capacity, pump is operated at too low speed.

Alarm allows normal operation of the system and it may be set off in option menu by disabling **AL**.

Collector pump will be started, unless other alarm is on and the reservoir is not overheated.

During alarm the collector temperature indicator shows current temperature in collector and blinks all.

Collector maximal temperature

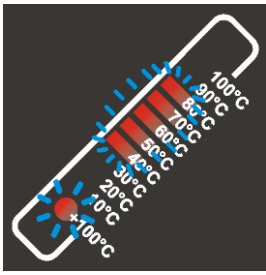

Alarm on reaching the collector maximal temperature 180°C. Alarm stops the collector pump operation. Alarm will be off when the collector temperature drops below 178°C and the pump operation will be allowed.

Collector pump operation will be stopped.

During alarm the collector temperature indicator shows current temperature in collector. Segments 10, 20, 30°C are not lit.

9. SWITCHING OFF



To switch the controller off, keep the knob depressed for about 3 seconds in displaying mode. If the controller is in other mode, first leave the mode.

To leave edition mode, confirm set value or keep the knob depressed for 3 seconds or leave the controller for 10 seconds and it will close the selection mode.

To leave the selection mode, keep the knob depressed for 3 seconds or leave the controller for 10 seconds.



After switching the controller off, the pump operation will be stopped.

9.1. Test of unit

When switched on, the unit undergoes some testing. At the time the display shows alternately the testing screen and the software version.

Testing screen should illuminate all segments of display; they should be lit with the same light. If any segments are not lit during the testing screen display, it indicates the controller damage. Contact your local service.

Software version will be useful at possible contacts with the service.

Software version is identified from lines that display the collector and the reservoir temperatures. Example of testing screen is presented in Fig. 9.1

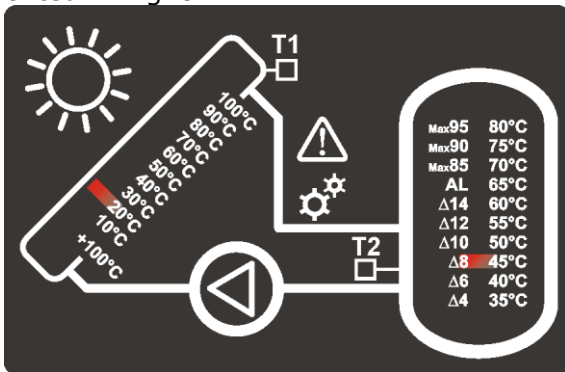

Fig. 9.1 Identifying software version

The example screen presents software version **1.20**

The table below includes numbers of software versions and corresponding temperature indications.

Collector temp.	Number 1	Reservoir temp.	Number 2
100°C	9	80°C	90
90°C	8	75°C	80
80°C	7	70°C	70
70°C	6	65°C	60
60°C	5	60°C	50
50°C	4	55°C	40
40°C	3	50°C	30
30°C	2	45°C	20
20°C	1	40°C	10
10°C	0	35°C	0
		1	20

INSTALLATION MANUAL

PCSol 150

10. TECHNICAL DATA

Measurement inputs	solar collector temperature (T1, terminals 9 and 10)
	d.h.w. reservoir temperature (T2, terminals 11 and 12)
High-voltage output	DHW pump circuit control CWU P1(terminals P1L and P1N): 230V/0.5 A
Controller supply:	230 V, I=0.52A*, 50 Hz
Nominal impulse voltage	2500 V~
Operating conditions	0 ≤ Ta ≤ 40 °C, humidity 10-90 %, without condensation
Protection degree	IP 20
Weight	~280 g (controller only)
Dimensions WxHxL	140x95x40

* power intake only by controller is 0.02A

Table of temperature measurement accuracy:

Controller internal structure		Pt1000 class B (CT6 and CT6w)		
Temperature range		-40 ÷ 0 °C	0 ÷ 130°C	130 ÷ 210°C
Accuracy*		±3 °C	±2 °C	±3 °C
Displayed range / Step	T1	10 ÷ 200°C with step of 10 K		
	T2	35 ÷ 80°C with step of 5 K		
Measured range / Step	T1	-40 ÷ 210°C with step of 0,6 K		
	T2	-10 ÷ 110°C with step of 0,5 K		

* unit at ambient temperature of 23°C

10.1. Elements of the set

- Controller PCSol 150 1 pc.
- Temperature sensor T1(CT6w) 1 pc.
- Temperature sensor T2(CT6) 1 pc.
- Installation and operating manual 1 pc.

11. INSTALLATION

The controller is designed for operation in the environment where only dry conductive contaminations may be present (2 degree of contamination according to PN-EN 60730-1). In addition, the controller may not be used in water condensation conditions and it may not be exposed to water.

 The unit software does not ensure required protection level that must be assured by external protections of the system.

11.1. Installation of the controller

The controller is designed for vertical wall-mounted installation. Mounting hole locations are presented in **Fig. 15.1** External wires are supposed to be leaded out of the wall (flushed).



Before opening the unit casing, disconnect power supply. The unit installation must be done at disconnected voltage.



Controller must be installed by qualified and authorized technician in accordance with EN 60335-1 standard.

Fig. 11.1 shows how to open the panel



Fig. 11.1 How to open casing panel



Do not open casing by levering its cover from below. It will break the cover clip.

Fig. 11.2 Incorrect method of casing opening

- The controller must be installed in a way that:
 - ! Degree of protection is ensured suitably to environmental conditions
 - ! Dust and water access is prevented
 - ! Permissible operating temperature is not exceeded (40°C for controller)
 - ! Air exchange inside casing is allowed
 - ! Access to dangerous parts is disabled
 - ! Electrical installation, to which the controller is connected, must be equipped with the device that allows disconnection of both supply poles, in accordance regulations that applies to such systems

11.2. External circuits connection

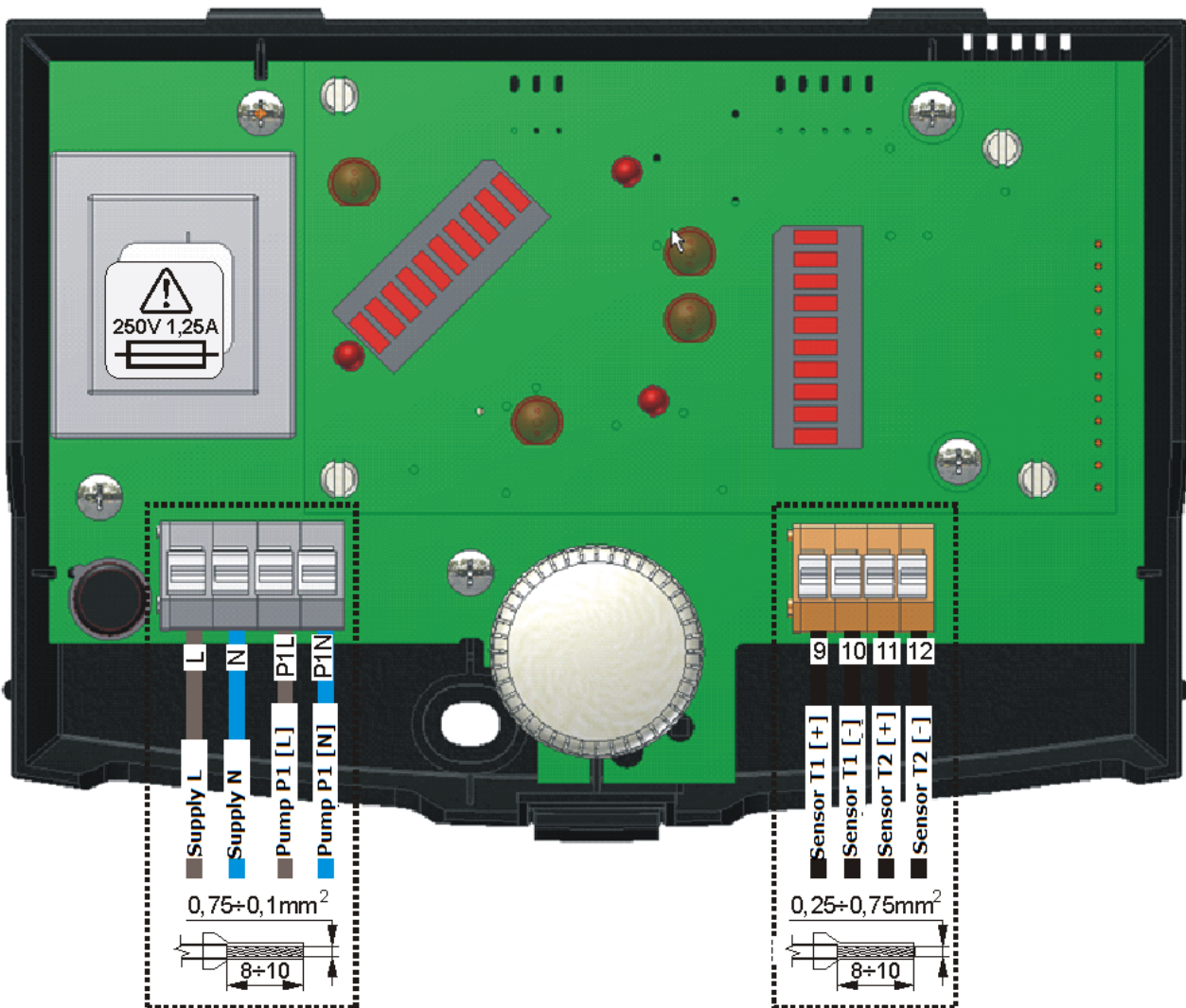

Fig. 11.3 Inside view with terminals

12. DIAGRAM OF CONNECTIONS

See below diagram of connections for PCSol 150 controller. Details of connecting to individual ports are presented in sections 12.1.2÷12.1.3



Presented hydraulic diagram will not replace central heating technical design and may be used only for informative purposes.



Collector and hot water reservoir must be installed in accordance with local regulations and their manufacturers' instructions.

12.1. Basic diagram of connections

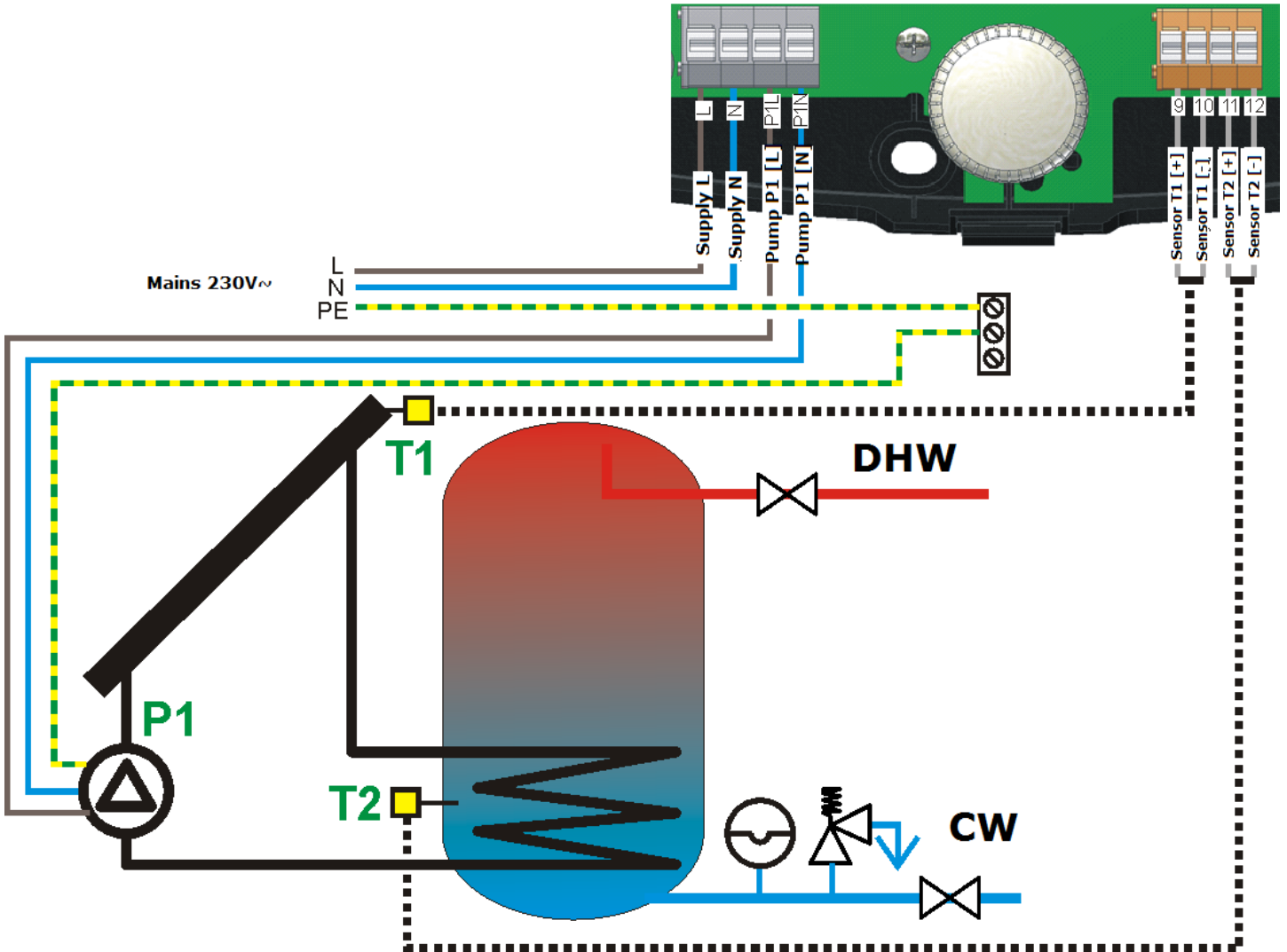

Fig. 12.1 Diagram of connections

12.1.1. Use of connectors

The controller is provided with spring loaded terminals suitable for reception of wire with an end sleeve.

The table below includes permissible size ranges for wires connected to the controller terminals:

Circuit type	Wire cross-section
Power supply circuits	0.75÷1mm ² *
Low-voltage circuits	0.25÷0.75mm ²

*For installations with bare wire cables the maximal size is 1.5mm²

For good connection between the terminal and cable, insulation and sleeve free length should be in the range of **8÷10mm**.

To place wire in terminal press the terminal push with flat screwdriver, insert the wire end (with a sleeve on) and then release the push.

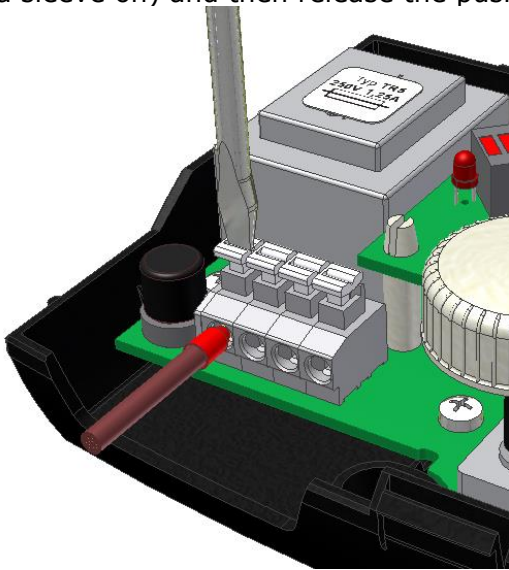

Fig. 12.2 Using clamped terminals

12.1.2. Power supply connection



Unit must be installed at disconnected power supply voltage.

The controller is designed for supply voltage 230V~, 50Hz. Supply is connected to terminals marked „→”, „L” and „N”. Electric connection diagram is presented in Fig. 12.3

230V supply wires must be lead so as their contact with sensor and other low-voltage cabling is prevented, additionally, all cables may not contact surfaces with temperatures that exceed the cables operating temperature limits.

The controller has no PE protective connector, because the controller itself does not require grounding. PE terminals of the pump shall be connected with PE of supply network, according to periphery instructions and regulation concerning electric systems. Proper electric installation method is responsibility of the electrician. It is recommended to connect PE circuits through external screw connector, as presented in diagrams.



Collector pump must be installed on the return from the reservoir

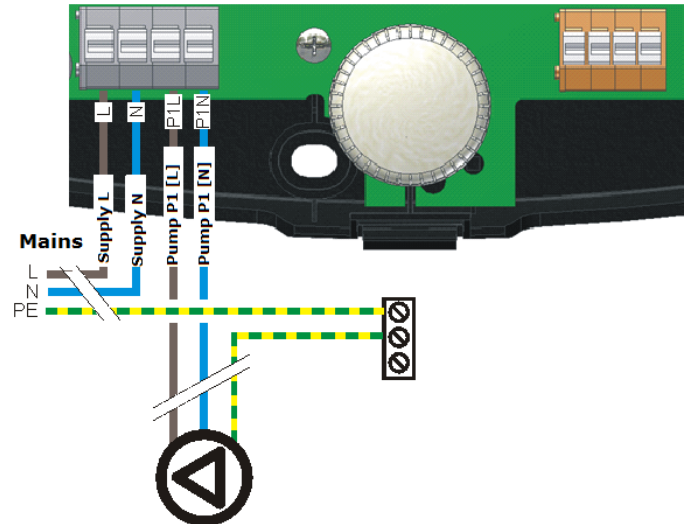

Fig. 12.3 Power supply connection

12.1.3. Temperature sensor connection

PCSol 150 controller works with temperature sensors with pt1000 structure, types CT6w and CT6, with the temperature ranges:

Sensor	Type	Temperature range
T1	CT6w (collector)	-40÷210°C
T2	CT6 (reservoir)	-10÷110°C

Sensor CT6 is provided in standard with 2m long cable, while the collector sensor CT6w with cable. If you need longer cables, use 0.5÷1.5mm² cable not longer than 30 meters, and connection points must be secured against short circuit and humidity.



CT6w sensor is provided with special high-temperature silica cables, it must not be replaced with CT6 sensor, because of possible insulation damage when the collector temperature is high.

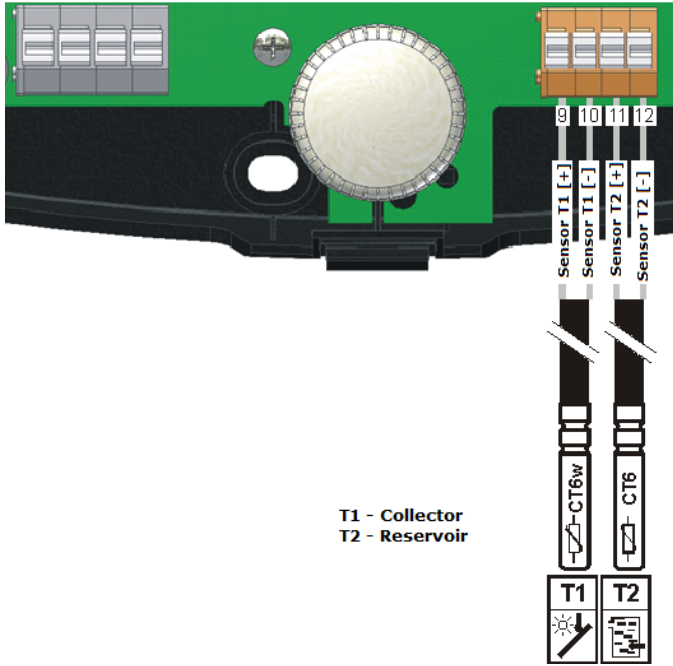

Fig. 12.4 Connection of temperature sensors

Temperature sensors are equipped with brass coat with diameter of 6mm and 50mm long. They should be installed possibly close to the temperature measurement point. The sensors must be installed so that the brass coat is thermally insulated from the environment.

The collector temperature sensor must be located in the collector tube possibly deep, as this is conditional for correct measurement.

The reservoir temperature sensor must be located in thermometric tube between the supply and return connectors of the collector exchanger pipe coil.

The sensors resistance per temperature table:

CT6w \ CT6			
Temp. °C	Min. Ω	Nom. Ω	Max. Ω
0	999,7	1000,0	1000,3
25	1096,92	1097,35	1097,77
50	1193,42	1193,97	1194,52
100	1384,26	1385,06	1385,86
125*	1478,59	1479,51	1480,44
150*	1572,2	1573,25	1574,30

*only for CT6w sensor

13. HOW TO CLOSE CASING

To close the unit casing hook the casing cover with recesses against the base insets (shown in Fig. 13.1)

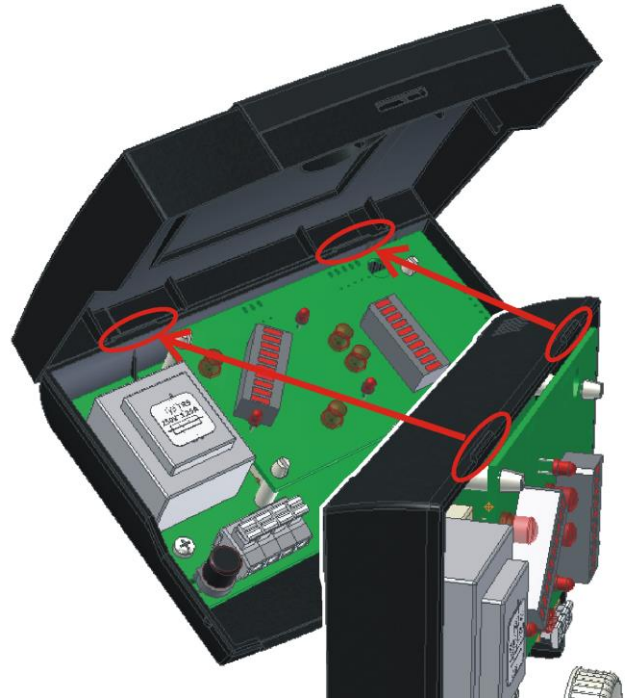

Fig. 13.1 Casing closing first step

Then, press the cover in place indicated by red arrow (Fig. 13.2), until you clearly hear the latch click.



Fig. 13.2 Casing closing second step

14. FUSE REPLACEMENT



Before fuse replacement, disconnect the unit from power supply.



It is not possible to check the fuse visually. Fuse may be checked by means of ohmmeter. Infinite resistance in the fuse circuit means that the fuse is burnt and must be replaced.

For the unit use sub-miniature slow blow fuse 1.25A compliant to IEC 60127 and with maximum switching current not lower than 100A. Example of such fuse is **slow blow fuse 1.25A type MXT-250** (from Schurter). To replace the fuse, disconnect the controller from power supply, open its casing and replace the burnt fuse with a new one (Fig. 14.1)

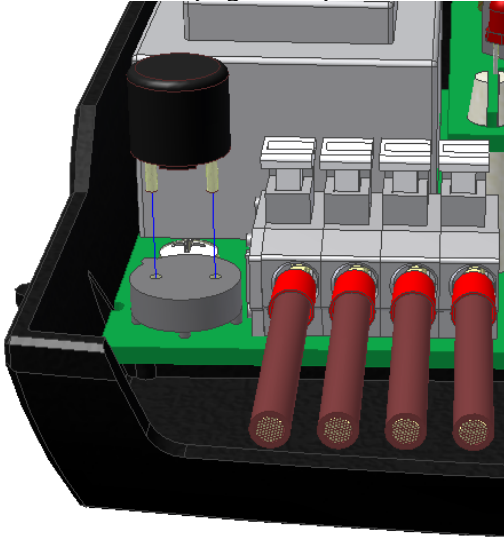

Fig. 14.1 Fuse replacement

15. TROUBLESHOOTING

Symptom	Remedy
Controller is not working	<ol style="list-style-type: none">1. Start the controller by keeping its knob depressed for at least 2 seconds2. Check power supply3. Check fuse in the controller
Controller alarms on collector overheating	<ol style="list-style-type: none">1. Collector pump runs at too low speed2. Collector pump capacity is too low, pump is not able to transfer heat to reservoir exchanger3. Temperature preset for reservoir has been reached and controller has disabled the pump. Collector pump is switched on by collector's critical temperature; relevant laud alarm may be set off in options.

Record of changes

First edition

Rev. 1.1 z of 20-04-2012

1. Update of unit current



The manufacturer reserves the right to make changes in design and software without prior notice



Presented drawing is in 1:1 scale and it may be helpful during installation. You may cut off this page and use to mark installation place

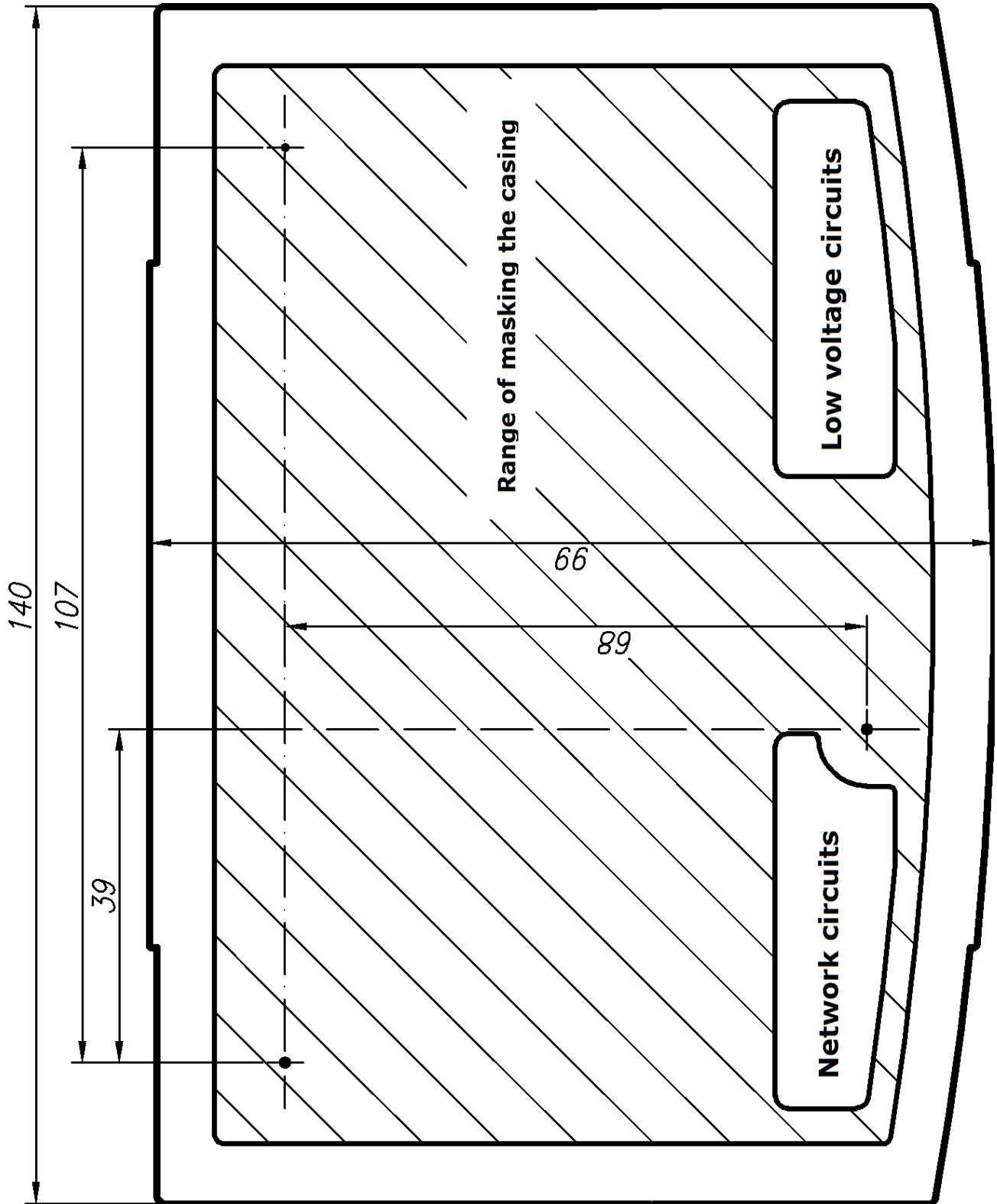

Fig. 15.1 Casing drawing for installation aid





SALUS Controls
Made in Poland